

LG-011-H Gleitkopf

LG-011, Führungswagen

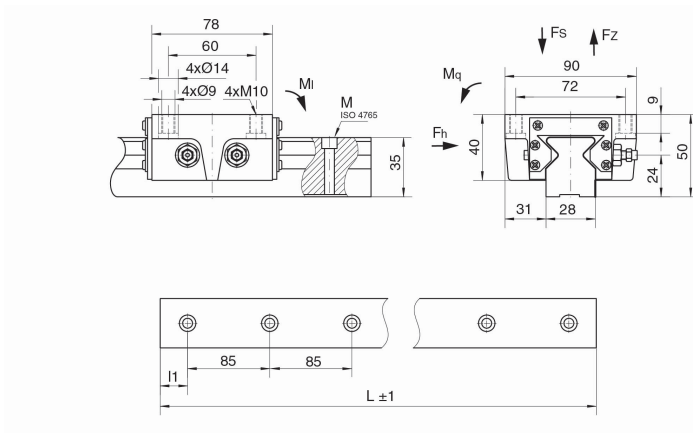

Produktbeschreibung:

LG-011, Gleitkopf

Artikeleigenschaften:

Selbstschmierend	Ja
Schmierstoff	Graphit
Basismaterial	Sondermessing (SO#50SP2)

Variantentabelle:

Artikelnummer	Artikelbezeichnung	Fs (kN)	Fz (kN)	Fh (kN)	Mq (Nm)	MI (Nm)
70110010	LG-011-H	16	16	13	270	540